

THE INFORMATION CONTAINED IN THIS DRAWING IS THE SOLE PROPERTY OF U.S. FOUNDRY & MANUFACTURING CORP. ANY REPRODUCTION IN PART OR AS A WHOLE WITHOUT THE WRITTEN PERMISSION OF U.S. FOUNDRY & MANUFACTURING CORP. IS PROHIBITED. U.S. FOUNDRY & MANUFACTURING CORP. RESERVES THE RIGHT TO MAKE MODIFICATIONS TO DESIGN WITHOUT PRIOR NOTICE. DRAWING IS UNCONTROLLED WHEN PRINTED. WEIGHTS AND DIMENSIONS ARE PROVIDED FOR REFERENCE ONLY. © 2015 US FOUNDRY AN EAGLE MANUFACTURING COMPANY

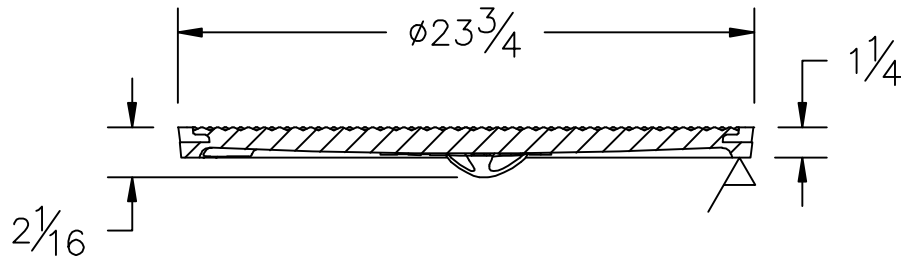

2x Non Penetrating Pick Holes

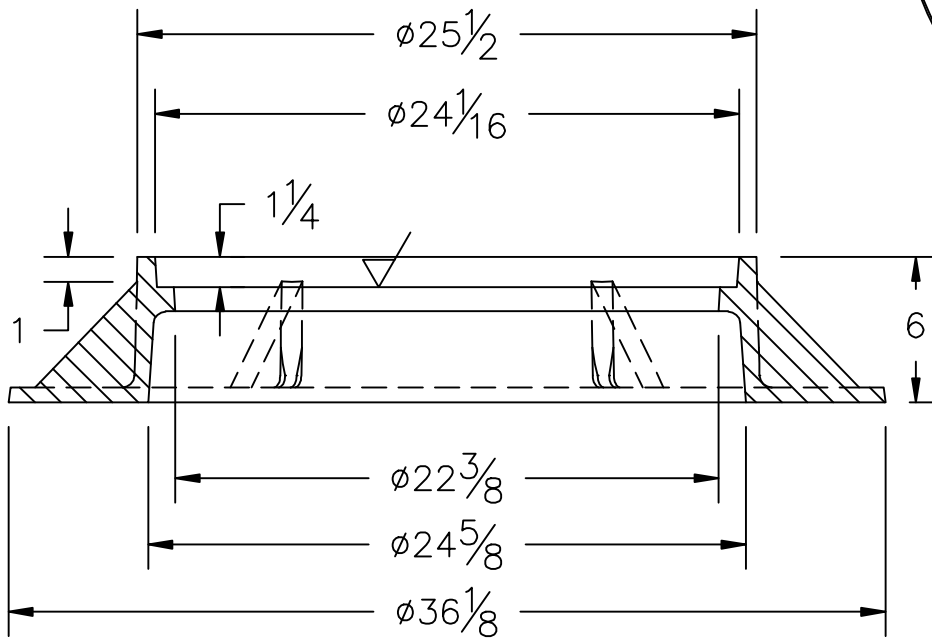
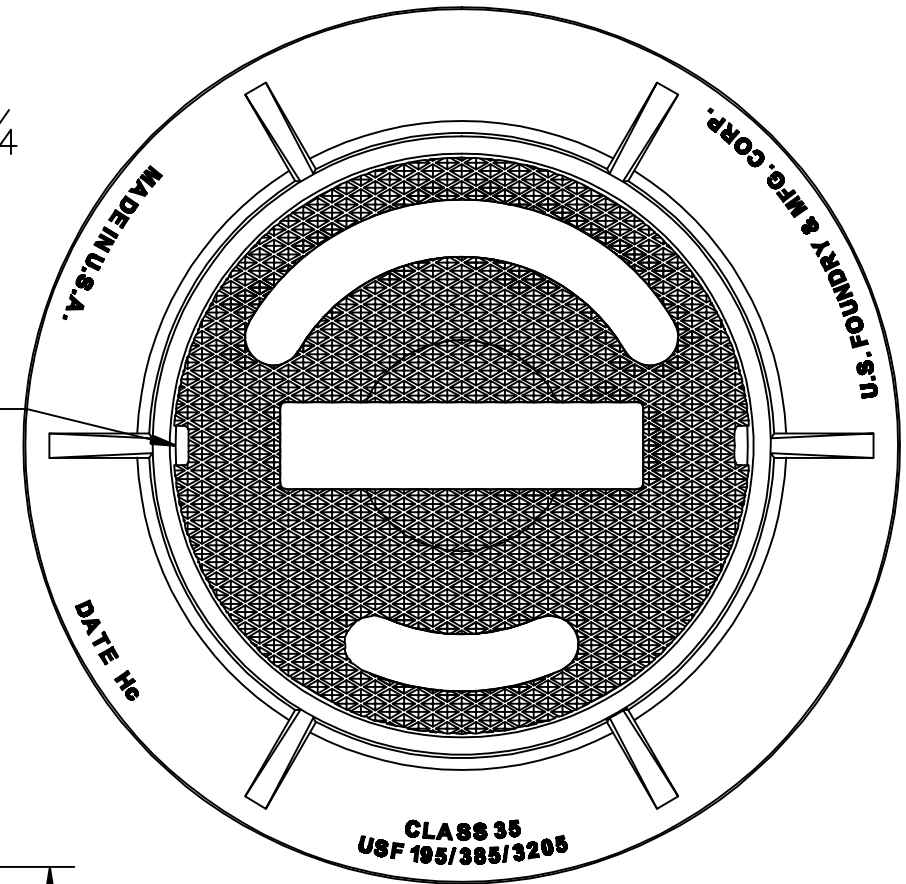

US FOUNDRY
 AN EAGLE MANUFACTURING COMPANY © 2015 All Rights Reserved

8351 NW 93rd Street
 Medley, FL, 33166-2025
 ph: 1-800-432-9709
 fax: 305-887-9429
 www.usfoundry.com

USF 195 Ring & CE-1 Cover

LOAD CLASSIFICATION: Heavy Duty		
MATERIAL: ASTM-A48 GRAY IRON CLASS35B		
Ring No:	8020023	SCALE: 1/8"=1"
Cover No:		DATE: 6/17/2015
		OWN. BY: ULS
REV: 0	DATE:	REV BY:
		QUOTE#